

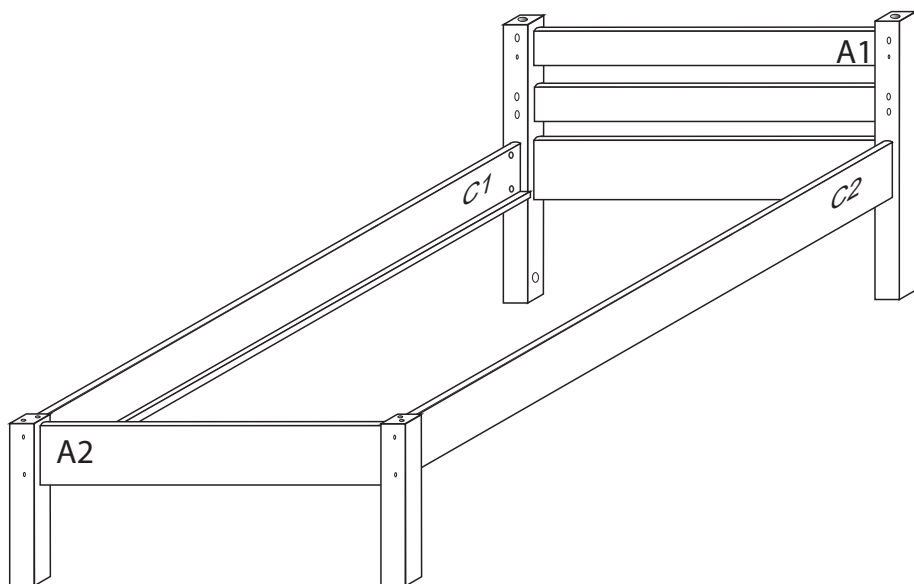

# DOMINO





985x2105x680

č. D 935

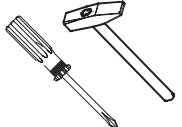
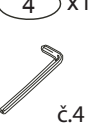
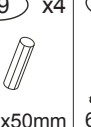
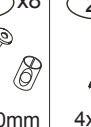
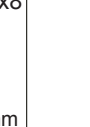

 Kolíky vždy narazte nejprve do otvorů ve hranách dílců, je nutné je zarazit se stejným přesahem. V případě, že některý kolík přesahuje, je nutné jej zakrátit. Dílce srážejte kladivem pouze přes dřevěnou podložku.

V případě vrzání vtlačte do spoje tekuté mýdlo v poměru 1:1 s vodou. Tento jev se u nábytku z masivu vyskytuje běžně.

	 4 x1 č.4	 9 x4 10x50mm	 12 x8 6x100mm	 29 x8 4x40mm
	 87 x6 5mm	 88 x4 7mm	 89 x6 10mm	 90 x4 25mm

